

SPIELPLATZ

(477 x 251 x h304cm)

003_01345_29012015

MONTAGEANLEITUNG

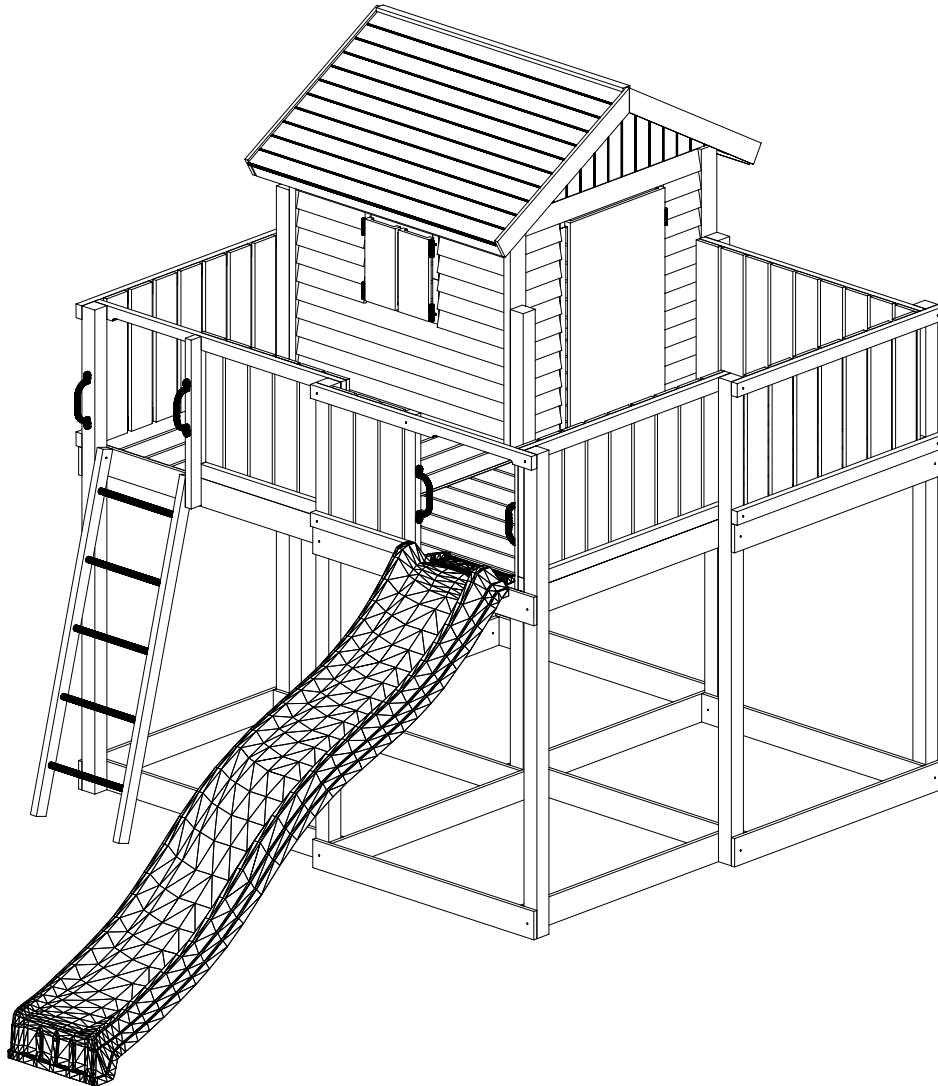

ACHTUNG!

Nur für den privaten, häuslichen Bereich.

Ausschließlich für die Verwendung im Freien.

Nicht geeignet für Kinder unter 3 Jahren.

Stolper- und / oder Sturzgefahr

Höchstgewicht pro Einzelkind beträgt 50 kg

Der Aufenthalt auf diesem Spielturm ist max. : 11.

Kindern gleichzeitig erlaubt.

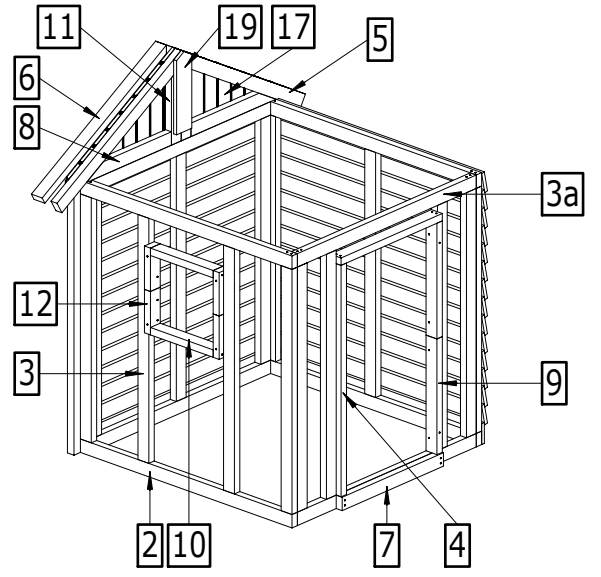
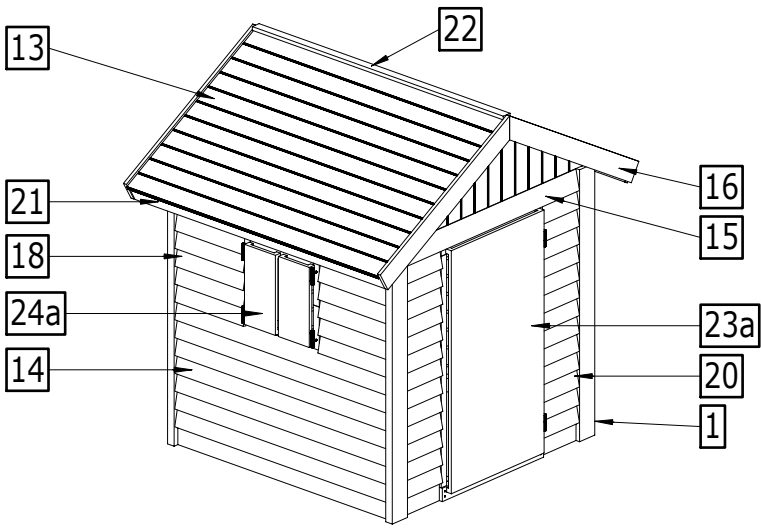

TA x2
00465

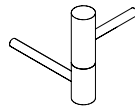

ZD x6
00338

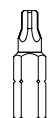

TX25 x1
00190



Ø5,5 x1
01372

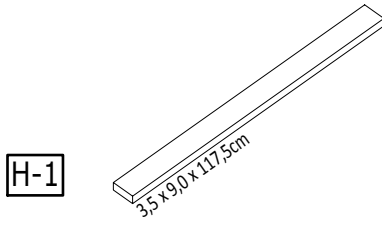

H-1

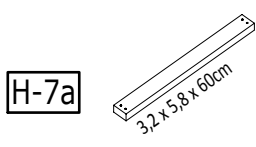

H-7a

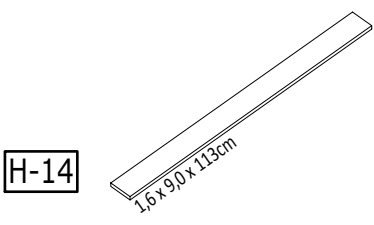

H-14

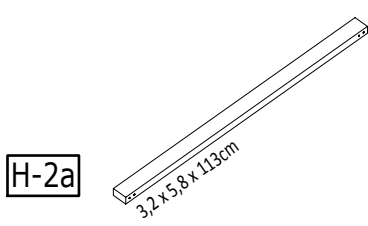

H-2a

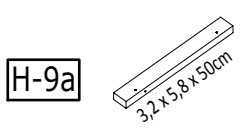

H-9a

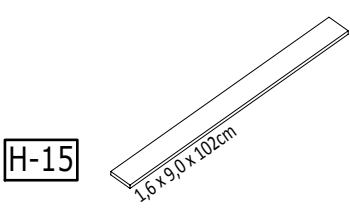

H-15

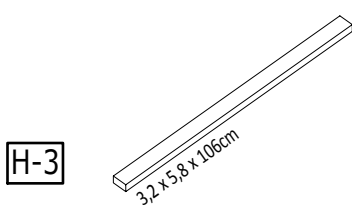

H-3

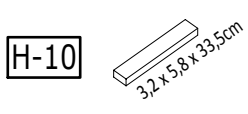

H-10

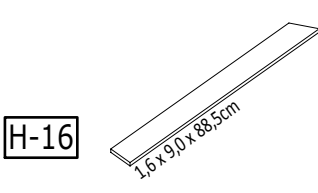

H-16

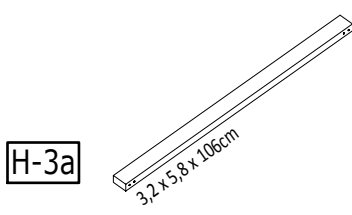

H-3a

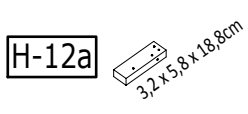

H-12a

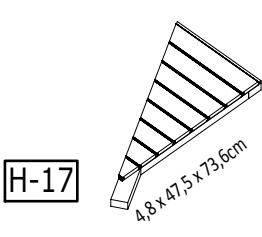

H-17

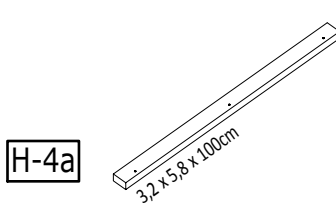

H-4a

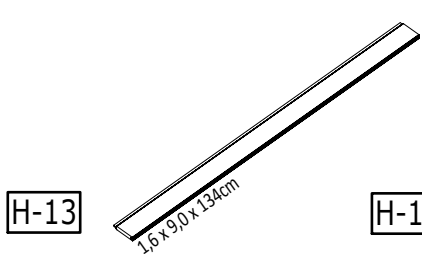

H-13

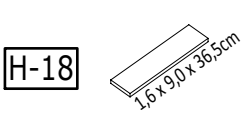

H-18

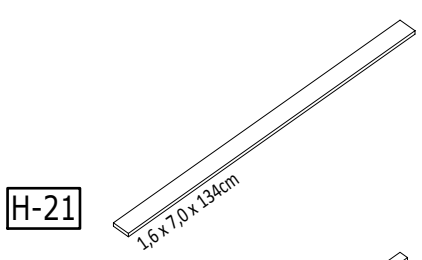

H-21

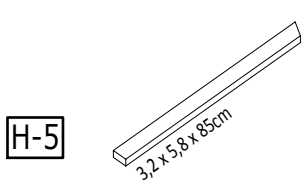

H-5

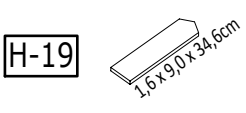

H-19

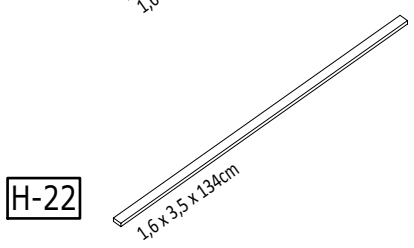

H-22

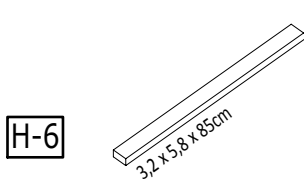

H-6

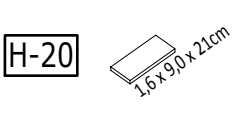

H-20

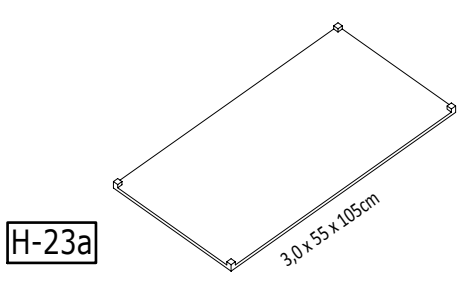

H-23a

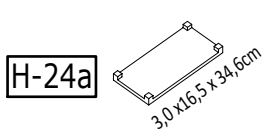

H-24a

H-1	35x90x1175mm	4
H-2a	32x58x1130mm	4
H-3	32x58x1060mm	14
H-3a	32x58x1060mm	4
H-4a	32x58x1000mm	1
H-5	32x58x850mm	2
H-6	32x58x850mm	4
H-7a	32x58x600mm	2
H-9a	32x58x500mm	2
H-10	32x58x335mm	2
H-12a	32x58x187mm	4
H-13	16x90x1340mm	22
H-14	16x90x1130mm	25
H-15	16x90x1020mm	18
H-16	16x90x885mm	4
H-18	16x90x365mm	10
H-19	16x90x345mm	2
H-20	16x90x210mm	28
H-21	16x70x1340mm	2
H-22	16x35x1340mm	1
H-23a	15x550x1050mm	1
H-24a	15x165x345mm	2
H-17	Halb-Spitzenwert	4

W80 x266



W40 x828



W20 x14



T80 x72

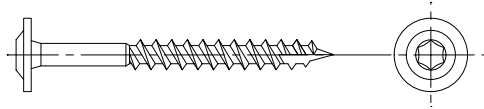

T60 x20

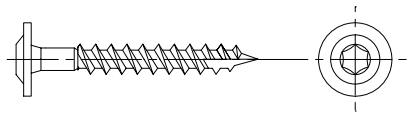

S50 x16

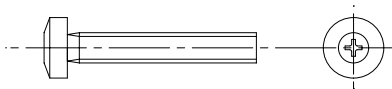

L11 x16

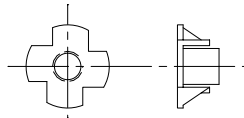

P17 x24

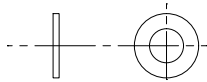

OS1 x66

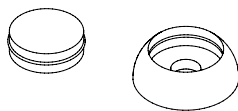

Ø3

00239

x1

Ø5,5

01372

x1

Ø10

00188

x1

PH3

00068

x1

PZ2

00241

x1

TX25

00190

x1

TX40

00242

x1

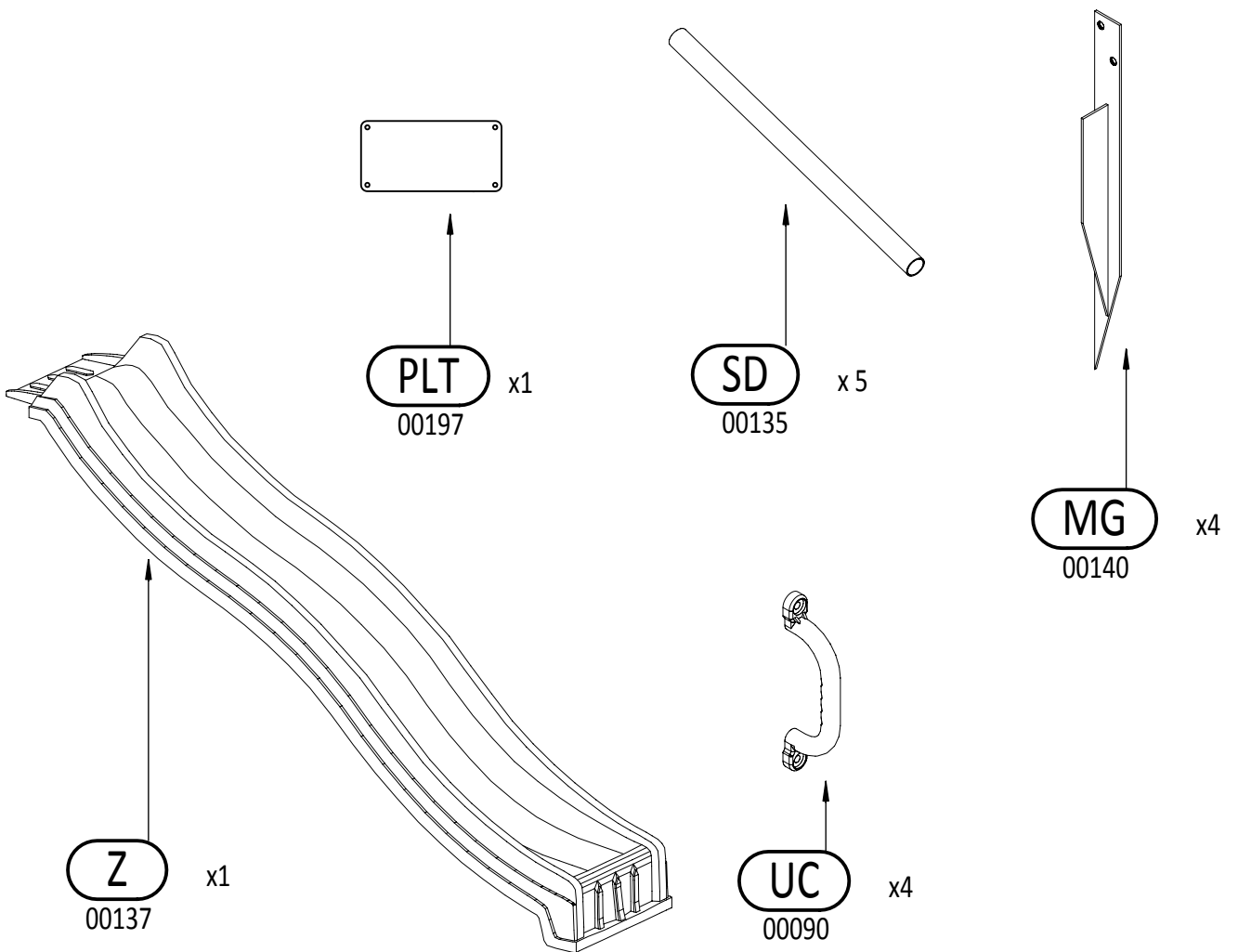
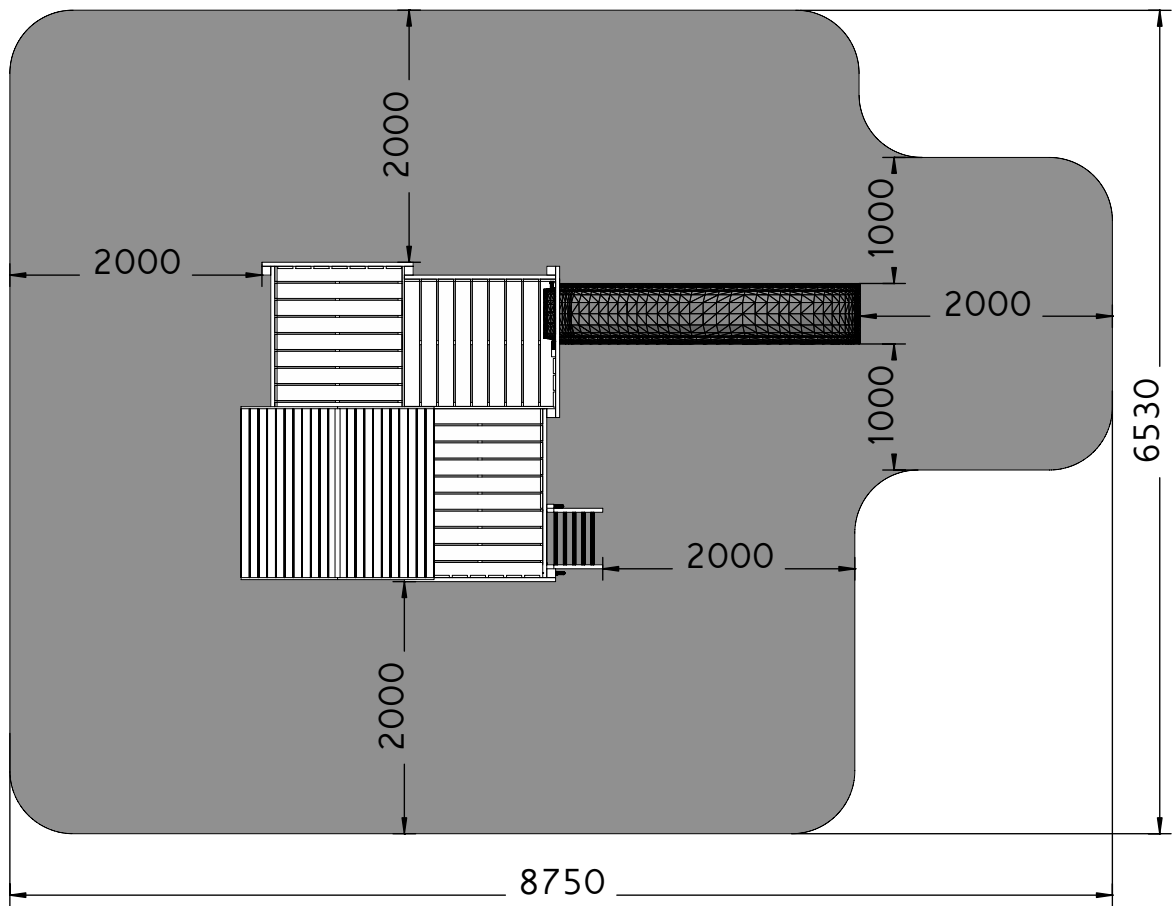

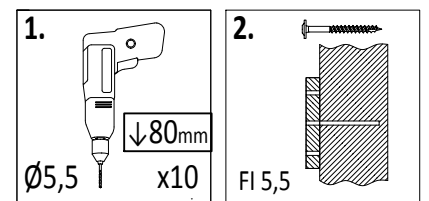
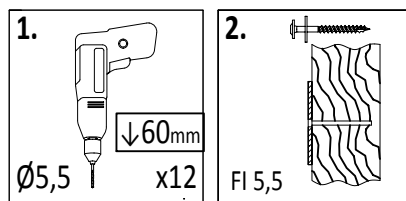
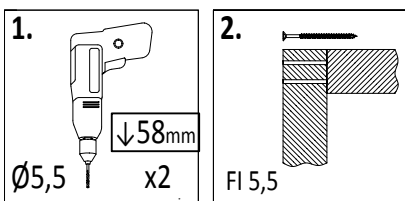
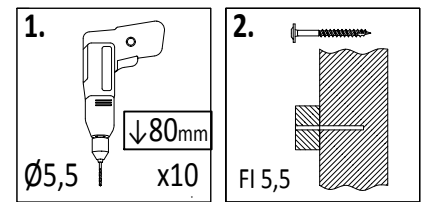
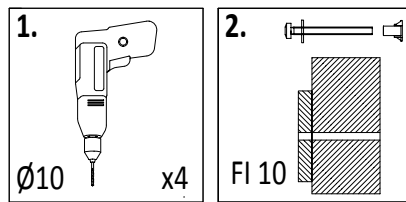
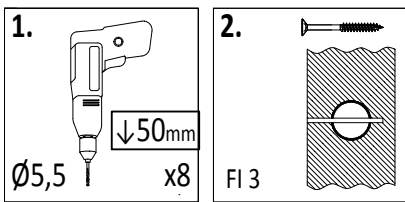
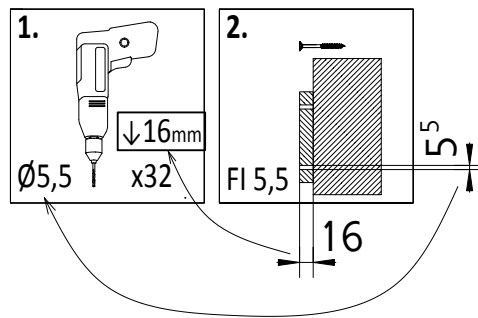
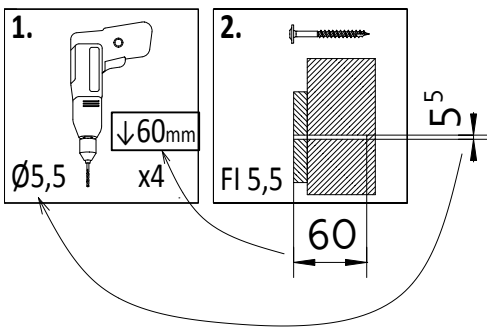
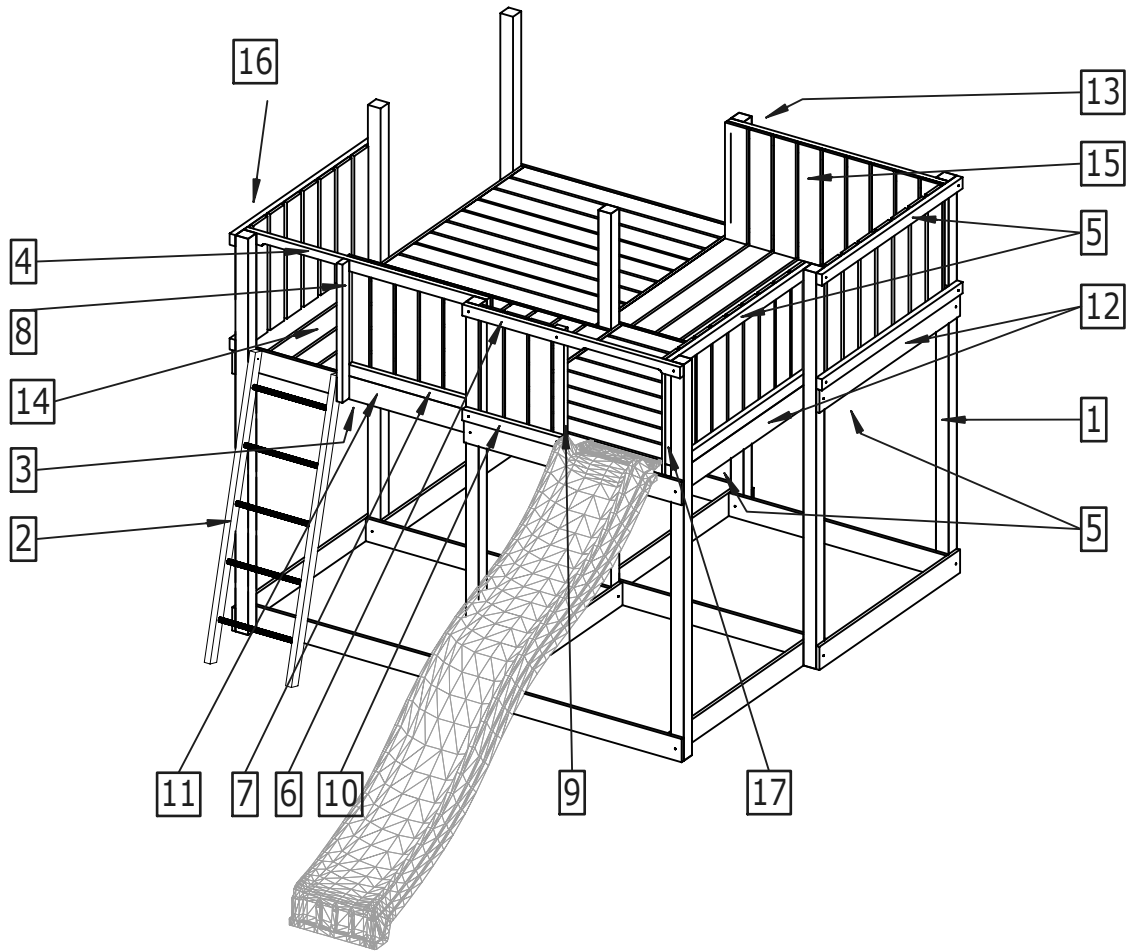

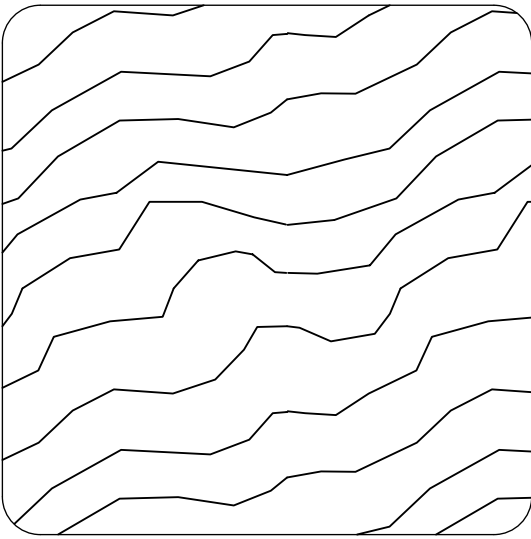

7,0 x 7,0 cm

Nr.	Maß	Stück
P-1	70x70x2250mm	2
P-2	70x70x2050mm	7

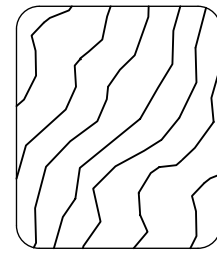

2,7 x 3,2 cm

Nr.	Maß	Stück
P-15a	27x32x542mm	1
P-16a	27x32x484mm	4

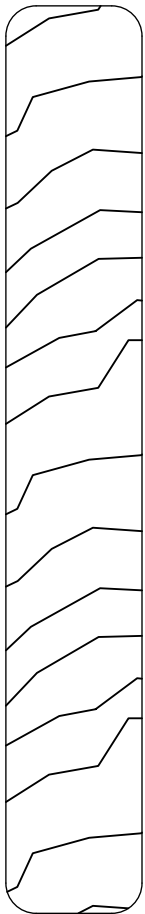

1,8 x 12,0 cm

Nr.	Maß	Stück
P-10a	18x120x1340mm	6
P-11a	18x120x1200mm	18
P-12	18x120x1164mm	9
P-13	18x120x1024mm	28
P-14	18x120x600mm	41

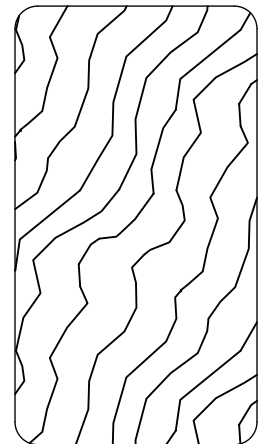

3,2 x 5,8 cm

Nr.	Maß	Stück
P-3a	32x58x1500mm	2
P-4	32x58x1340mm	3
P-4a	32x58x1340mm	1
P-5	32x58x1200mm	9
P-5a	32x58x1200mm	4
P-5b	32x58x1200mm	4
P-5c	32x58x1200mm	1
P-6a	32x58x790mm	1
P-7	32x58x715mm	1
P-8	32x58x600mm	1
P-9a	32x58x540mm	1

P-1

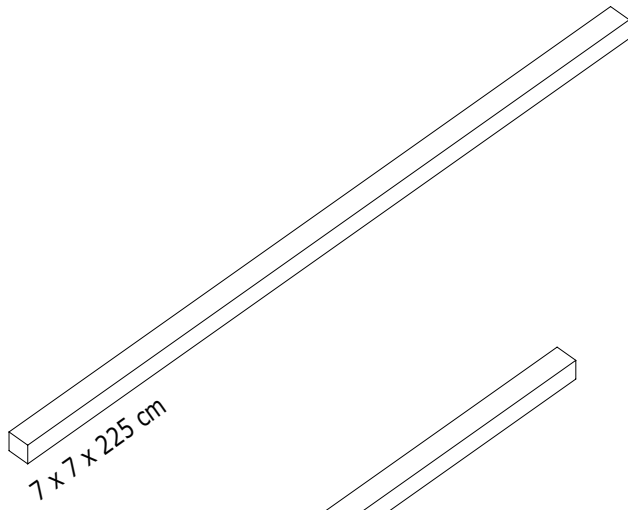

P-2

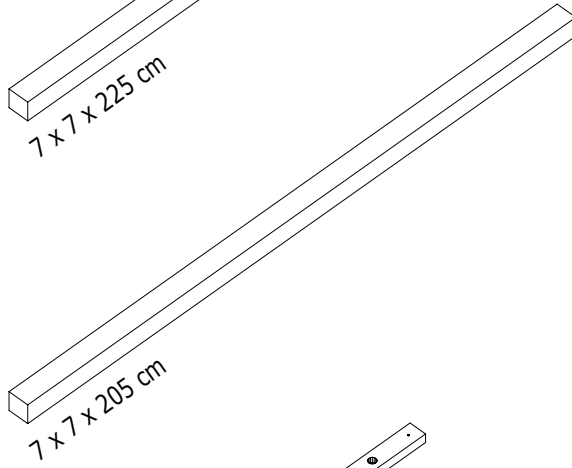

P-3a

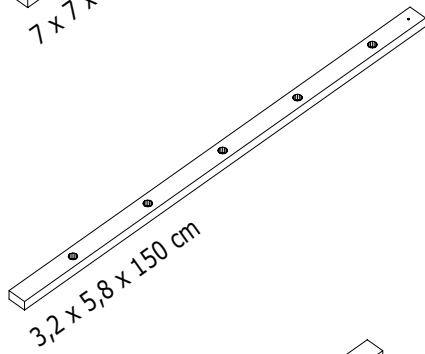

P-4

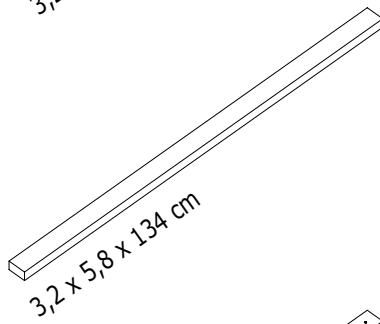

P-4a

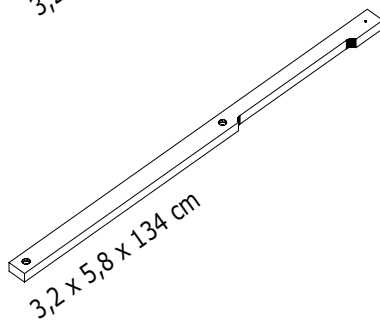

P-5

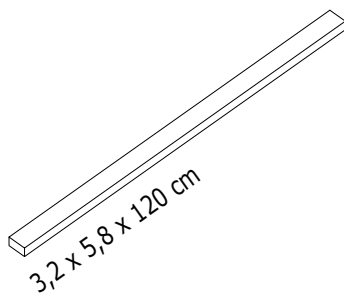

P-5a

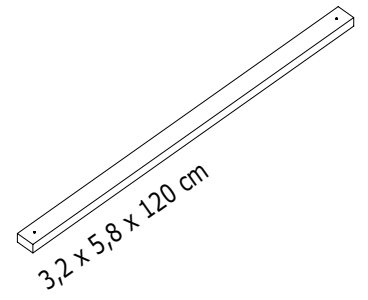

P-5b

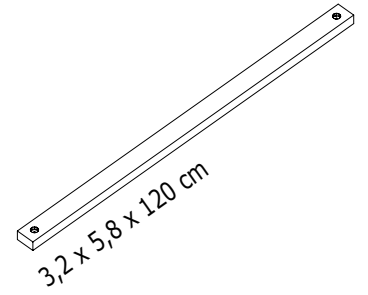

P-5c

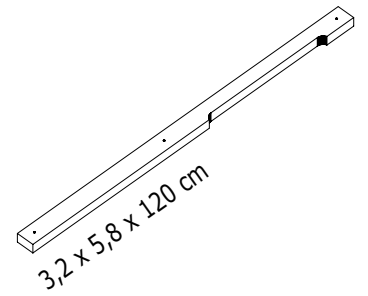

P-6a

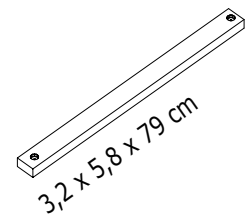

P-7

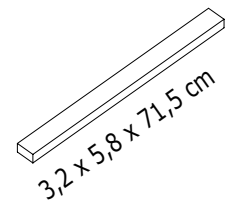

P-8

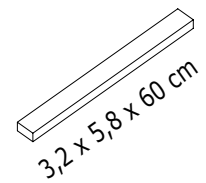

P-9a

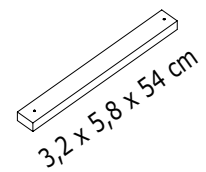

P-10a

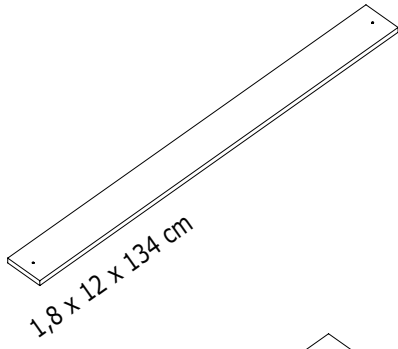

P-11a

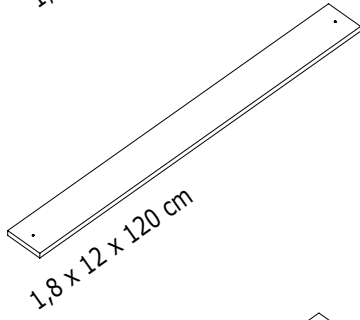

P-12

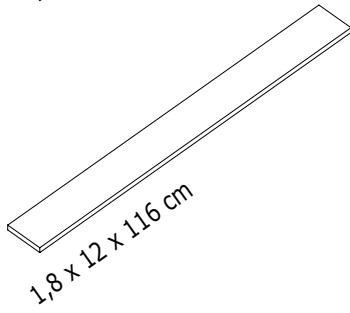

P-13

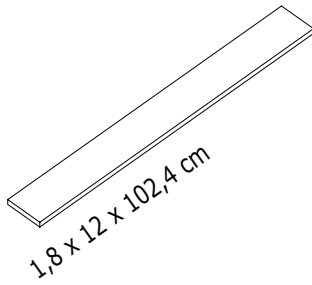

P-14

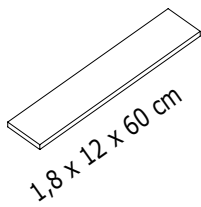

P-15a

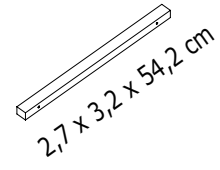

P-16a

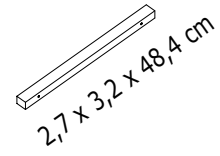

01

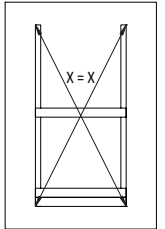
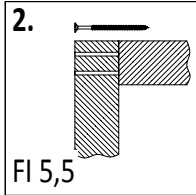
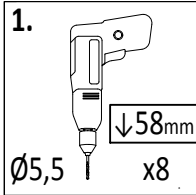

H-3a 3,2x5,8x106cm
x2

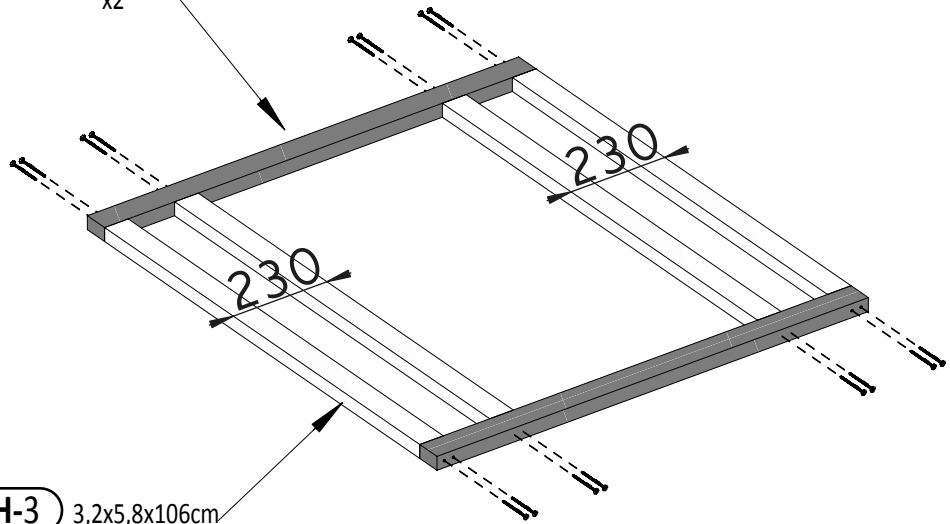

H-3 3,2x5,8x106cm
x4

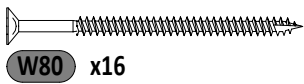

02

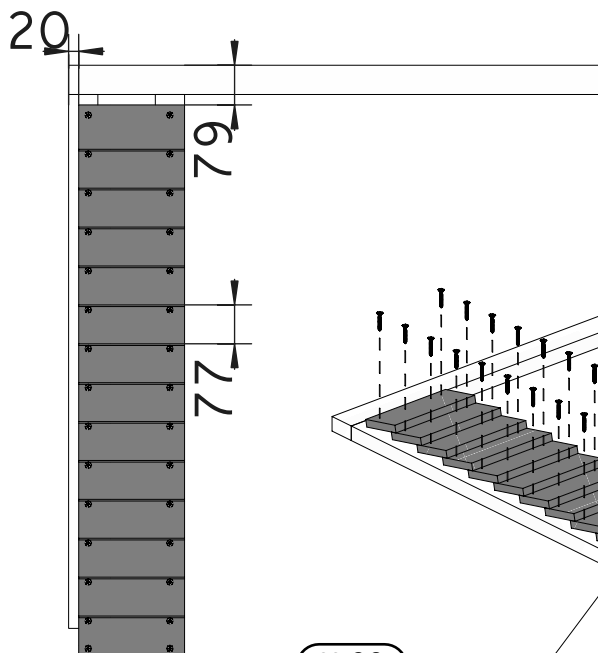
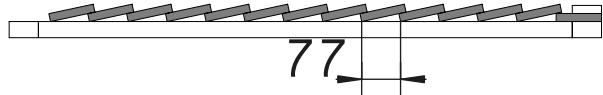
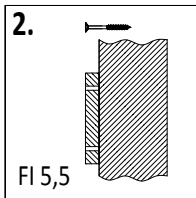
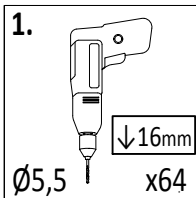

H-20 1,6x9,0x21cm
x28

H-7a 3,2x5,8x60cm
x1

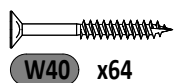

10

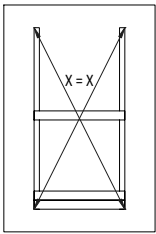

1. $\downarrow 58\text{mm}$
 $\varnothing 5,5$ x4

2. \downarrow
 FI 5,5

H-3a 3,2x5,8x106cm
x2

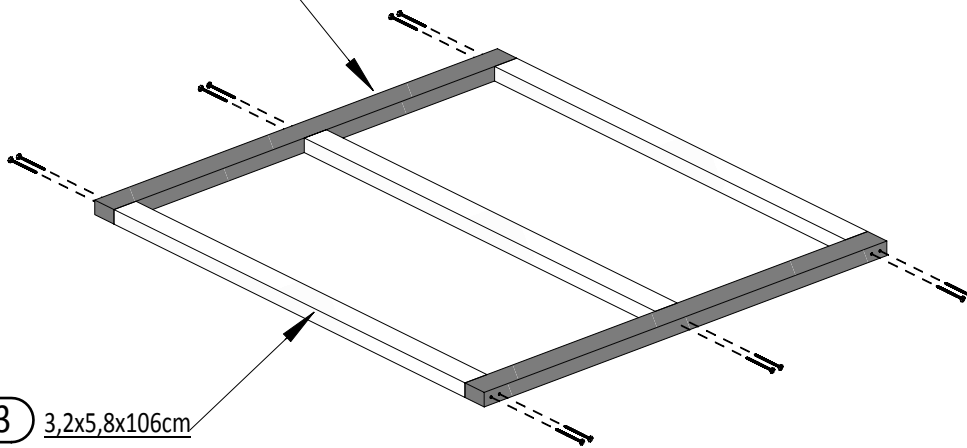

H-3 3,2x5,8x106cm
x3

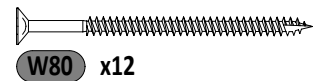

1. $\downarrow 16\text{mm}$
 $\varnothing 5,5$ x32

2. \downarrow
 FI 5,5

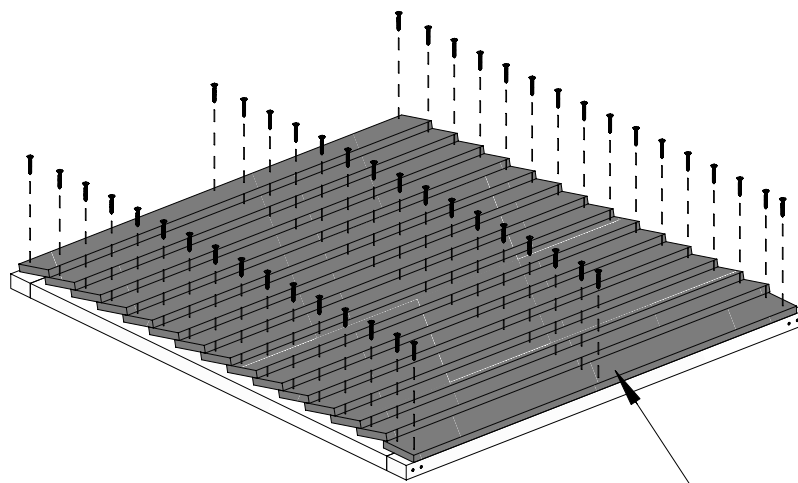
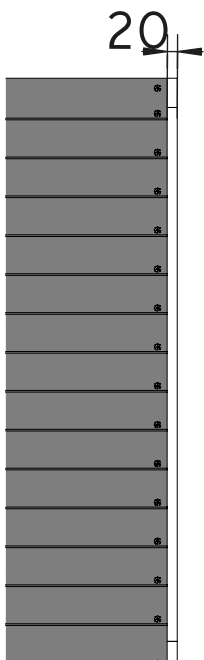
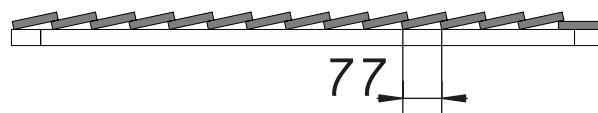

H-15 1,6x9,0x102cm
x15

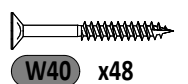

05

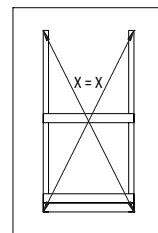
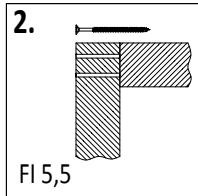
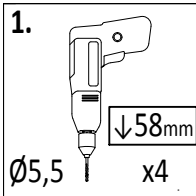

H-2a 3,2x5,8x113cm
x2

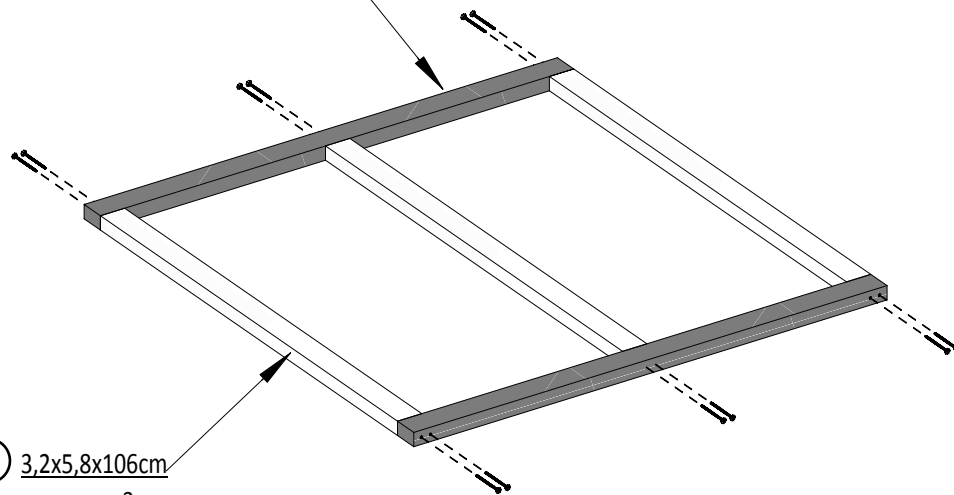

H-3 3,2x5,8x106cm
x3

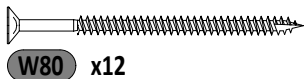

06

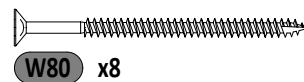
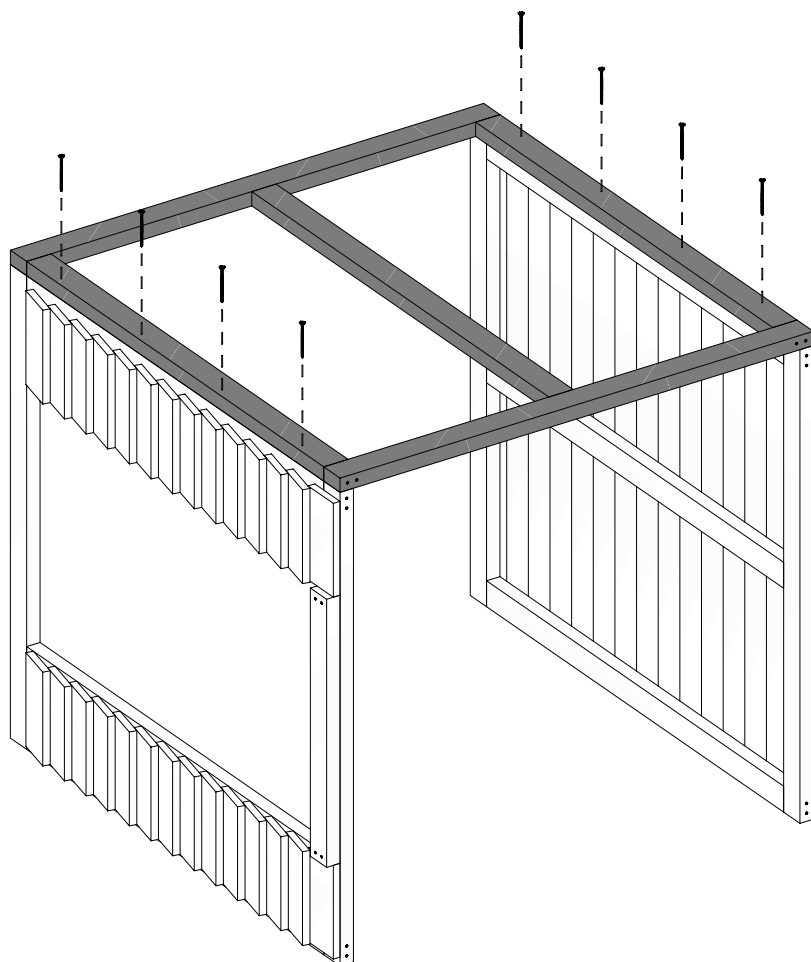
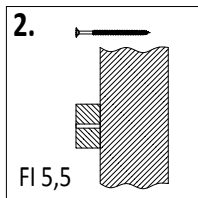
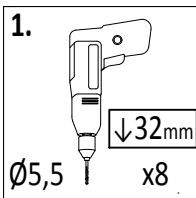

12

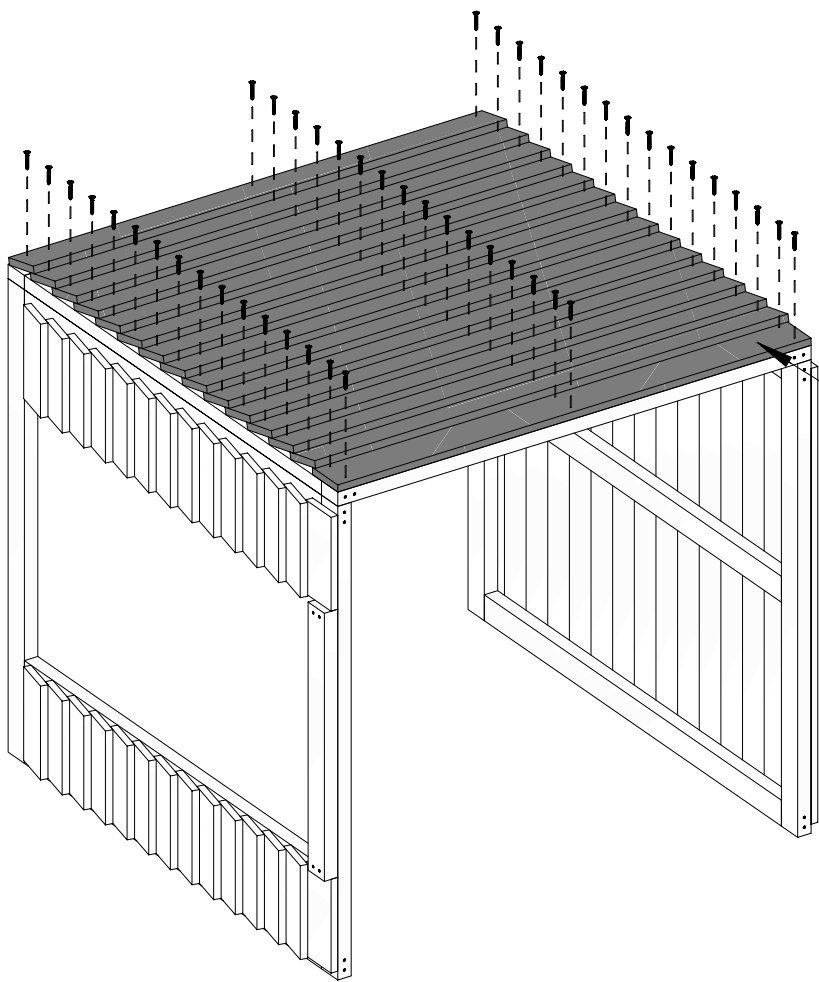

1.  $\downarrow 16\text{mm}$
 $\varnothing 5,5$ x48

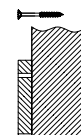
2. 
 FI 5,5

H-14 1,6x9,0x113cm
x15

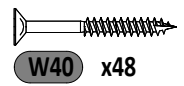

H-2a 3,2x5,8x113cm
x2

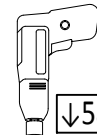
1.  $\downarrow 58\text{mm}$
 $\varnothing 5,5$ x8

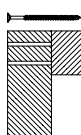
2. 
 FI 5,5

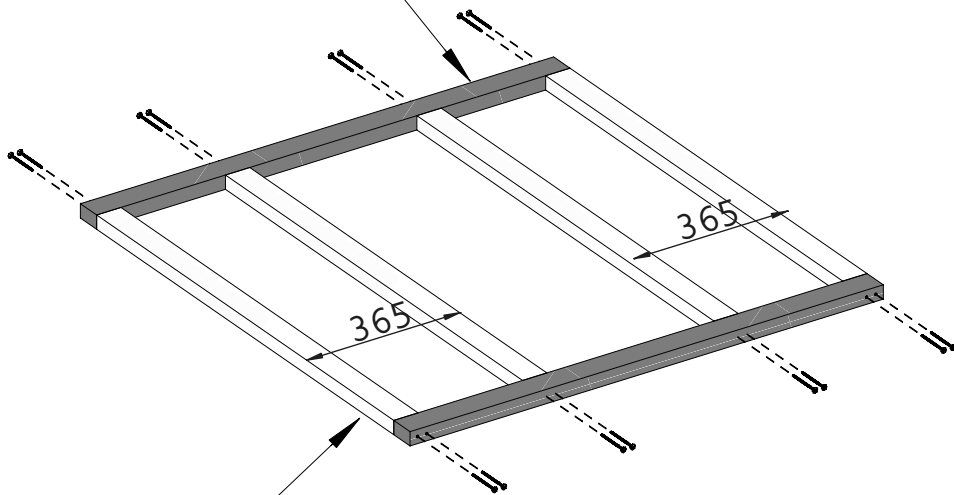
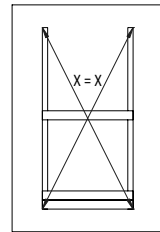

H-3 3,2x5,8x106cm
x4

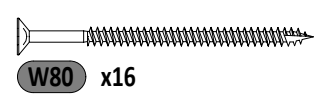

09

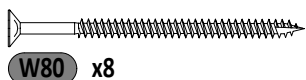
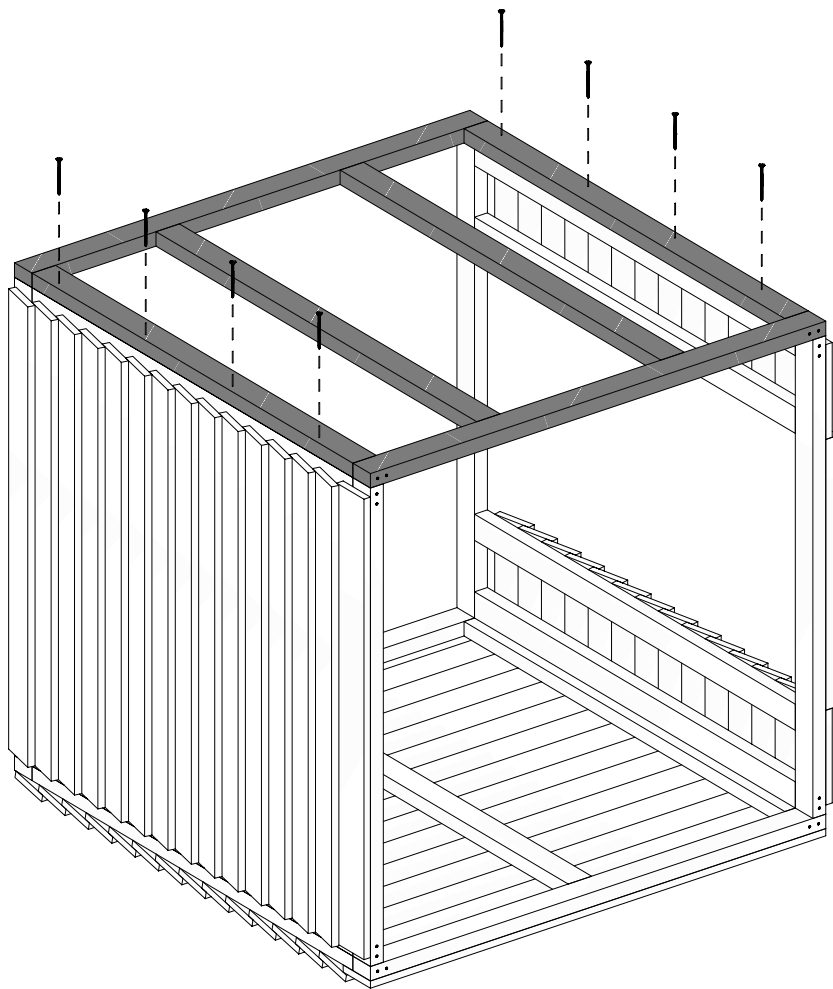
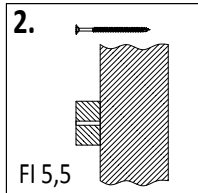
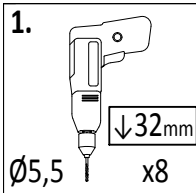

10

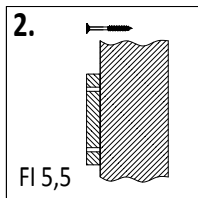
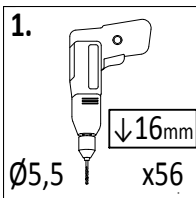

H-18 $1,6 \times 9,0 \times 36,5\text{cm}$
 x10

H-14 $1,6 \times 9,0 \times 113\text{cm}$
 x8

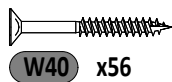
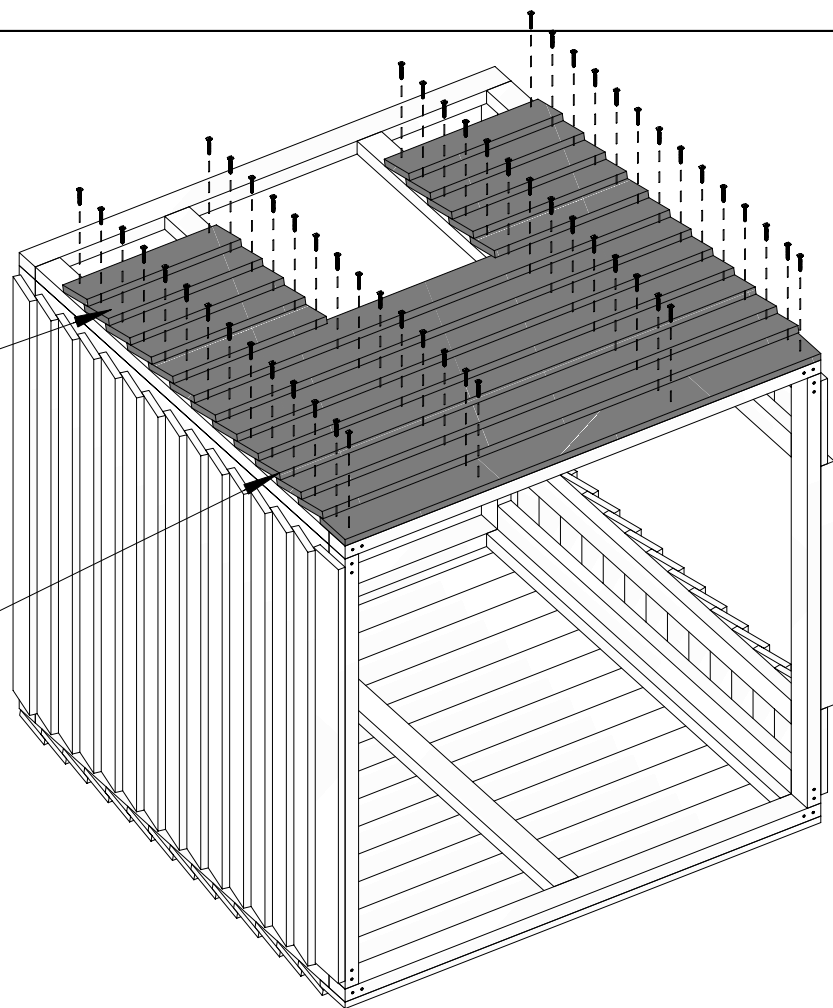

14

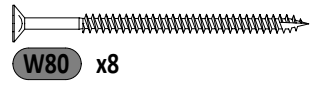
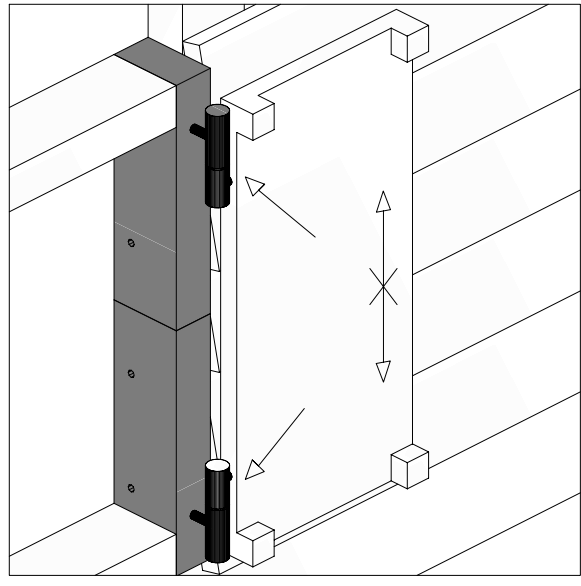
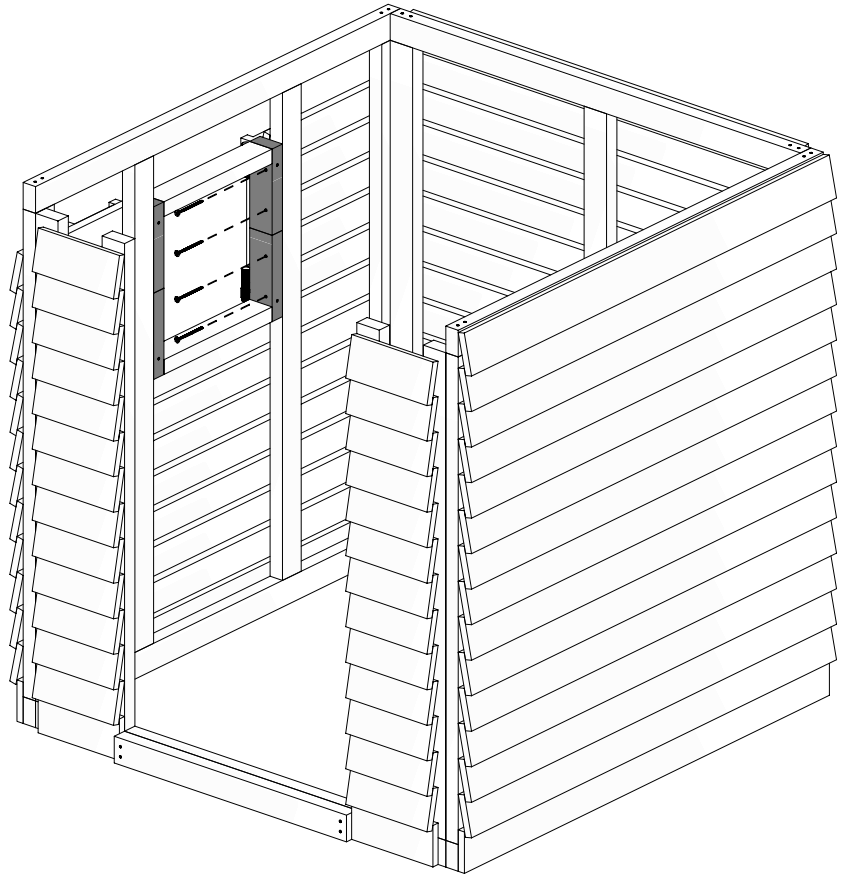
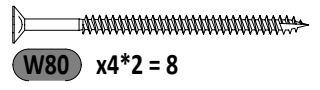
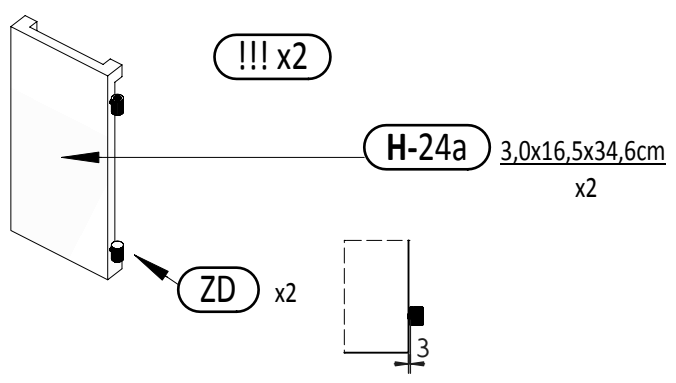
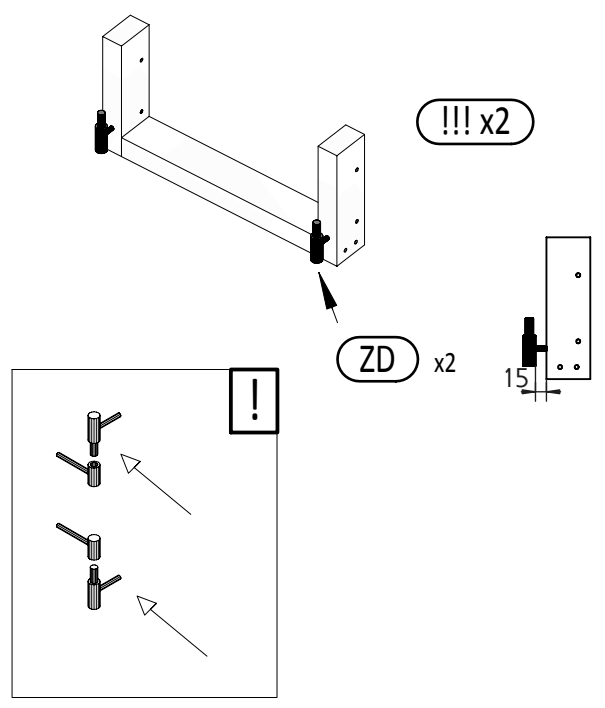
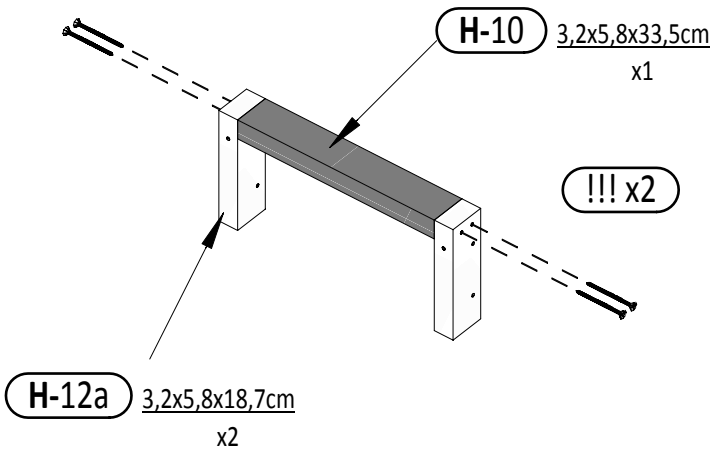

13

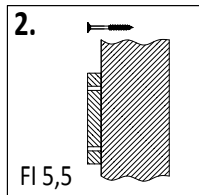
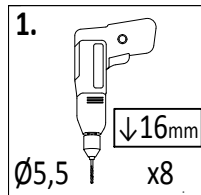

H-13 1,6x9,0x113cm
x2

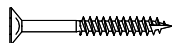
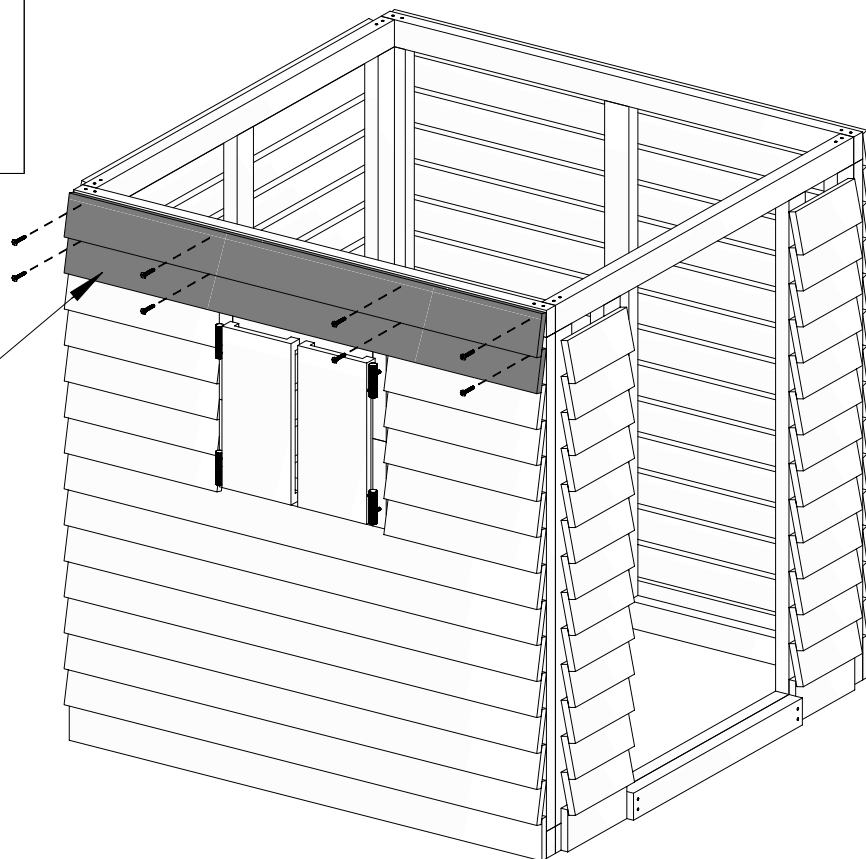

W40 x8

14

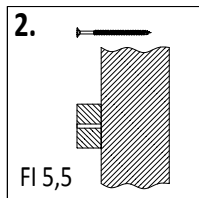
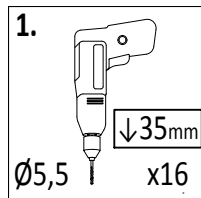

H-1 3,5x9,0x117,5cm
x4

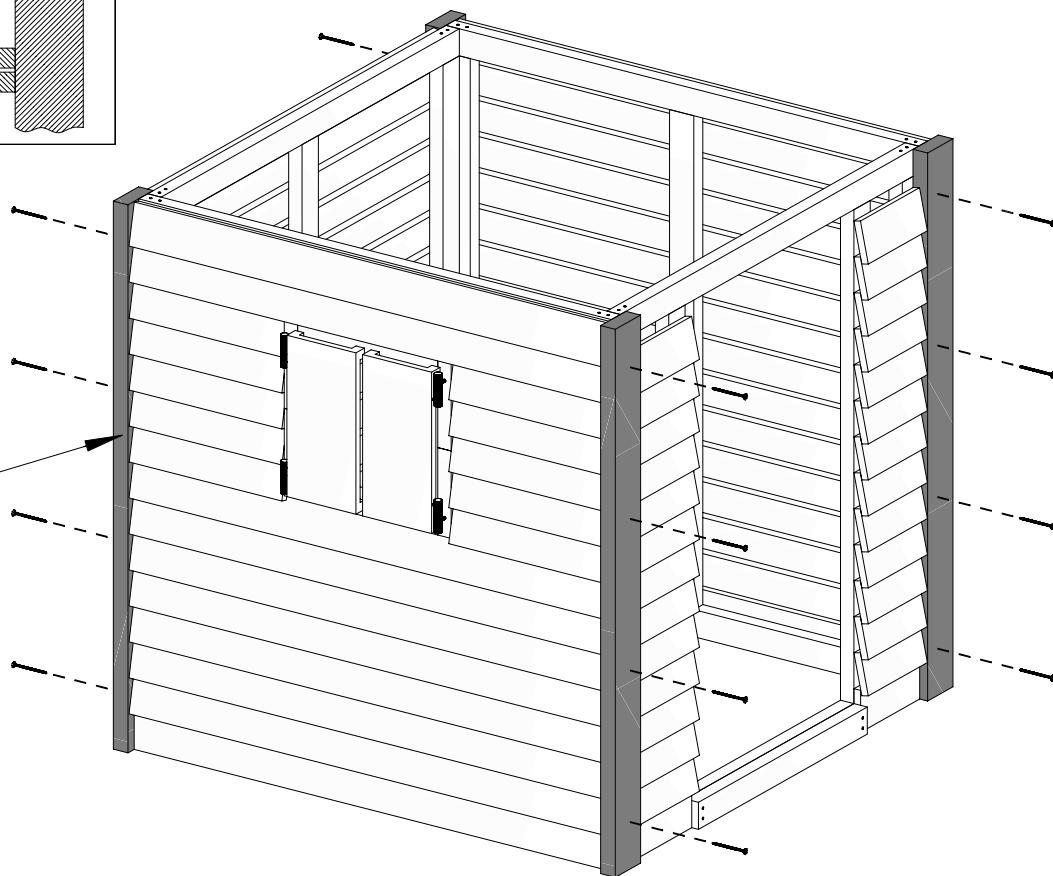

W80 x16

16

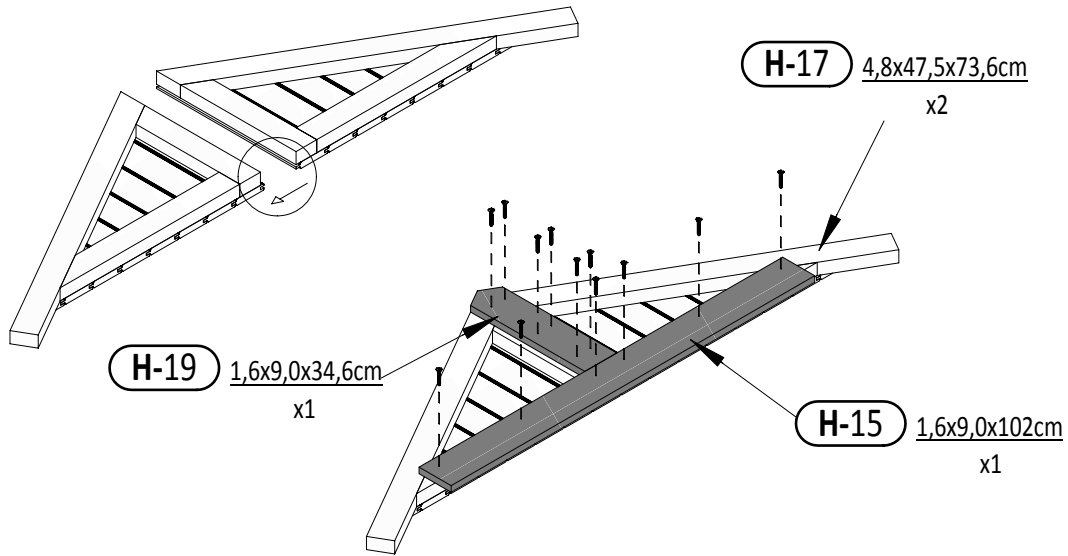
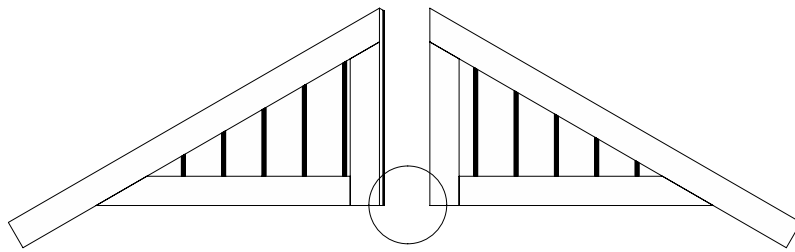

H-17 4,8x47,5x73,6cm
x2

!!! x2

H-19 1,6x9,0x34,6cm
x1

H-15 1,6x9,0x102cm
x1

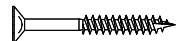

W40 x12*2 = 24

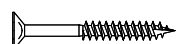
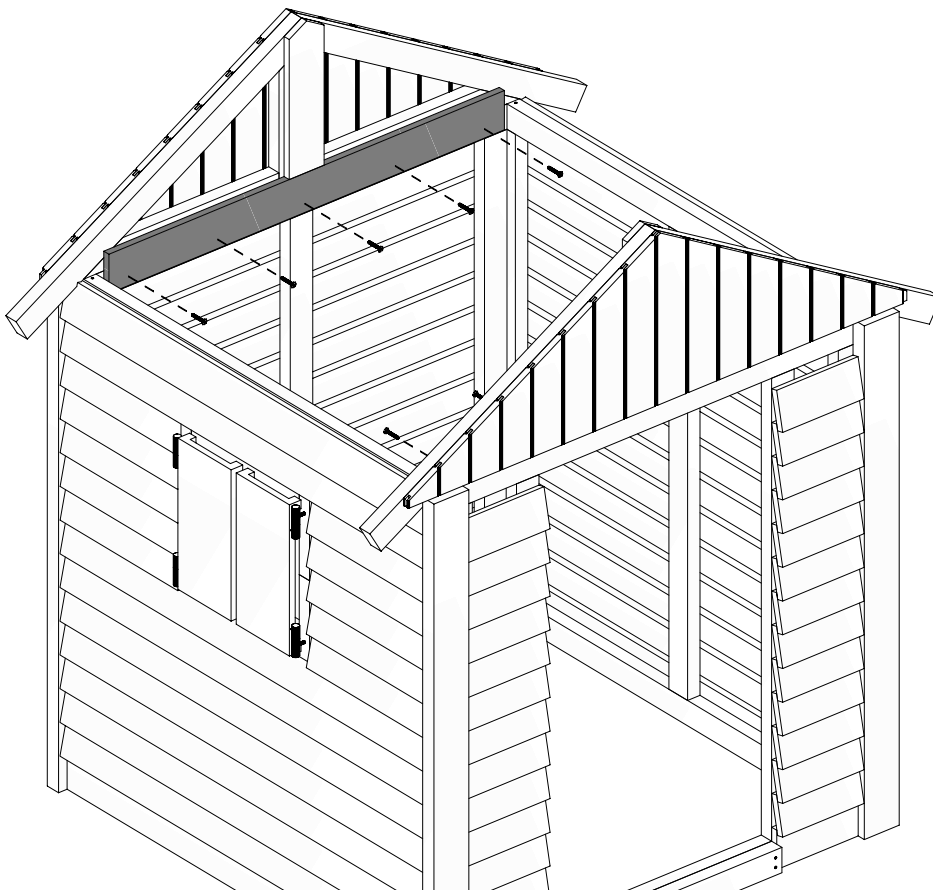

W40 x10

17

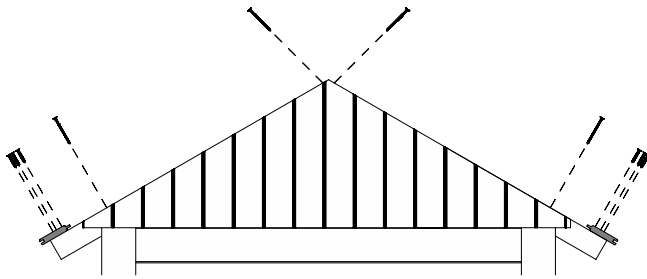

H-5 3,2x5,8x85cm
x2

H-13 1,6x9,0x134cm
x2

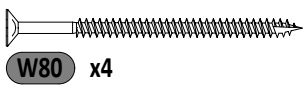
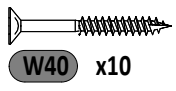
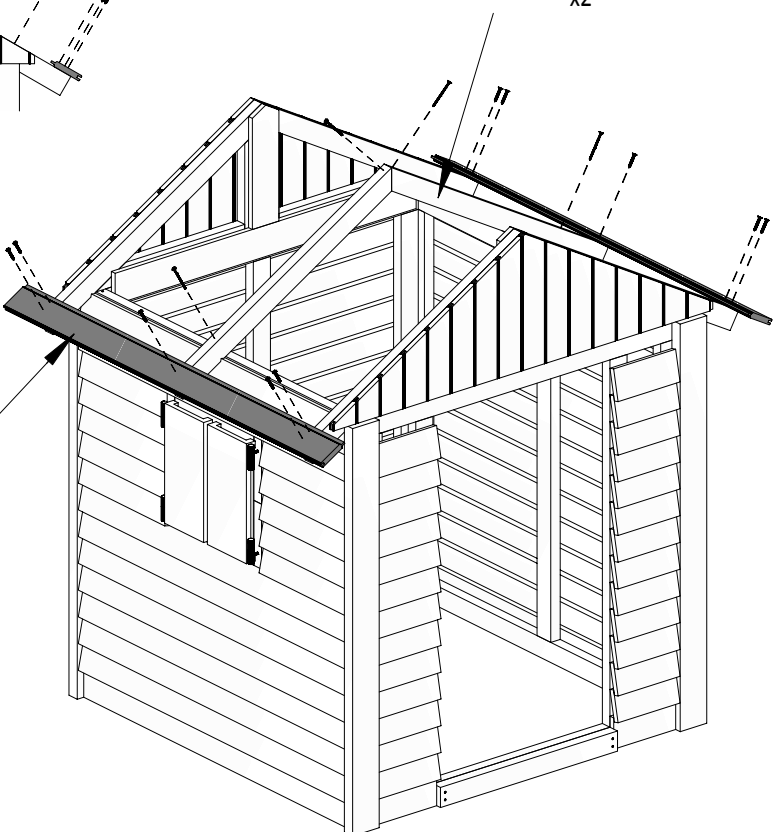

18

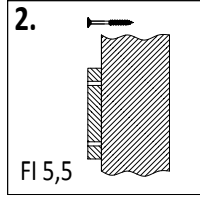
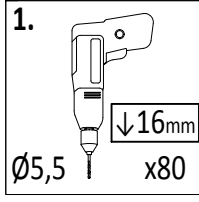

H-13 1,6x9,0x134cm
x20

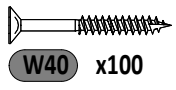
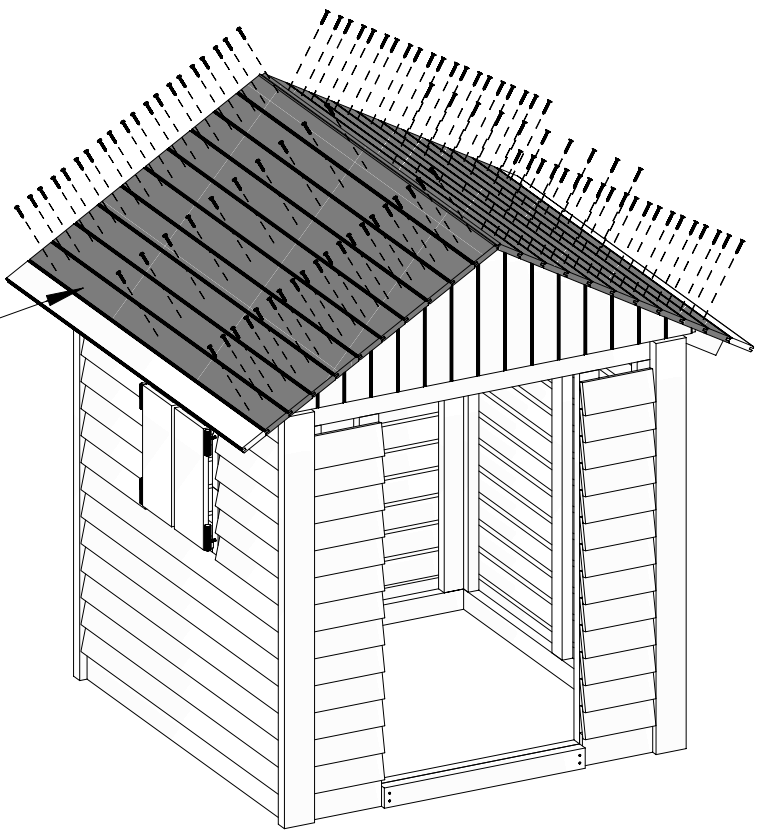

18

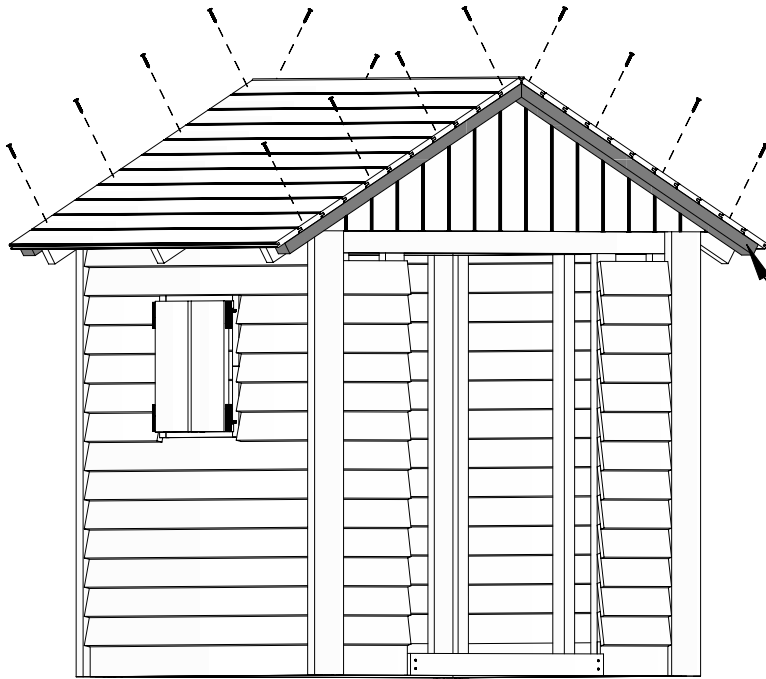
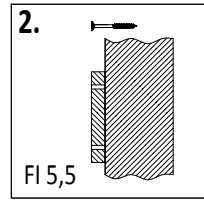
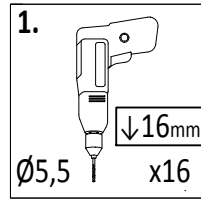
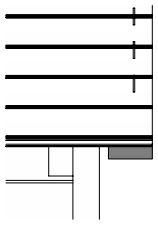

H-6 3,2x5,8x85cm
x4

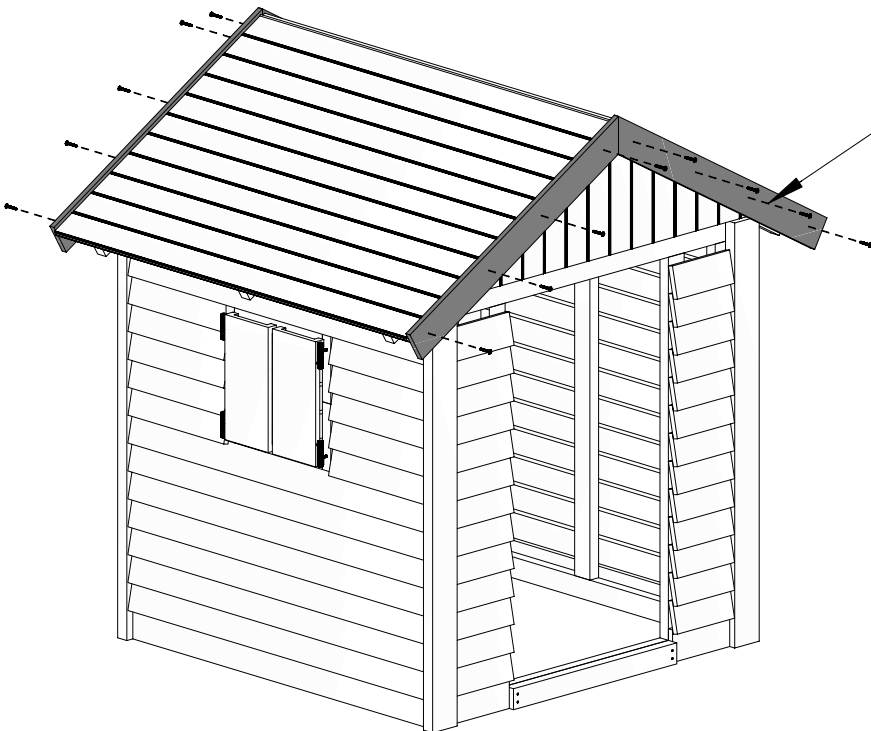
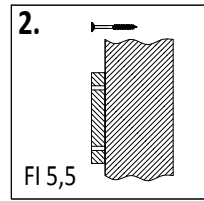
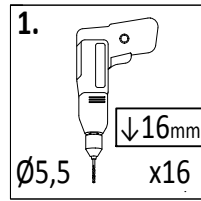
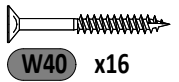

H-16 1,6x9,0x88,5cm
x4

